



il tuo punto fermo

SECONDA EDIZIONE 2013

ESSENZE E DECORATI



the company

i numeri del nostro successo

La Pail è un'azienda leader nel settore della produzione di porte interne e serramenti in legno, legno-alluminio, alluminio e PVC. Una realtà produttiva che conta oltre 200 dipendenti, suddivisi in quattro stabilimenti che coprono una superficie complessiva di circa 100mila mq (di cui 45mila mq coperti).

Produce annualmente 75mila porte interne, 15mila serramenti esterni, semilavorati e componenti in legno, destinati sia al mercato nazionale che a quello estero.

the numbers of our success

Pail is a leading company in producing internal doors and wooden, wooden-aluminium, aluminium and PVC windows. One productive world that has more than 200 subordinates shared on four factories, on about 100.000 mq surface (45.000 mq covered surface).

Every year Pail makes out 75.000 internal doors, 15.000 external windows, semi-manufactured and wooden components, for home and foreign market.



the family

Amministratore Unico e Legale Rappresentante:
Amerigo Pellegrini

Responsabile Produzione-Acquisti
Sandro Pellegrini

Responsabile Tecnico
Fausto Pellegrini

Responsabile Amministrativo-Finanziario
Paolo Pellegrini

Responsabile Commerciale
Emanuela Pellegrini





50 anni di storia

La nostra storia è quella di una piccola realtà artigianale iniziata 50 anni fa quando Amerigo Pellegrini, giovane falegname, fondò un laboratorio di soli 100 mq per la produzione di porte e finestre in legno. Oggi Amerigo Pellegrini è il presidente della Pail Serramenti, un'azienda che ha saputo evolversi in chiave industriale grazie alla profonda conoscenza del legno, al rispetto di antiche tecniche di lavorazione e alla costante ricerca per l'innovazione tecnologica. Sandro, Fausto, Paolo e Emanuela Pellegrini affiancano oggi il padre nella gestione di questa grande Azienda.

50 years history

This is a story about a small world, that began 50 years ago when Amerigo Pellegrini, young carpenter, started a craftmade lab on just 100 mq, in order to produce wooden doors and windows. Nowadays Amerigo Pellegrini is the President of the Pail Serramenti, a company that has been able to evolve in an industrial way, thanks to a deep knowledge of wood, thanks to respect for old work-techniques and steady research to technological innovation. Sandro, Fausto, Paolo and Emanuela Pellegrini stay by their father, managing this big Company.

1963

Inizio dell'attività di falegnameria
Start of carpentry

1972

Primo stabilimento industriale PAIL 1 (750 mq)
First industrial factory PAIL 1 (750 mq)

1975

Sviluppo mercato interregionale e prime commesse estere
Shop for the interregional market and the first foreign contracts

1985

Ampliamento stabilimento PAIL 1 a 6.000 mq
Factory expansion to PAIL 1 6.000 mq

1994

Apertura stabilimento PAIL 4 (10.000 mq)
Open factory PAIL 4 (10.000 mq)

1998

Apertura stabilimento PAIL 2 (18.000 mq)
Open PAIL 2 factory (18.000 mq)

2003

Apertura stabilimento PAIL 3 (10.000 mq)
Open PAIL 3 factory (10.000 mq)

2009

Avvio Divisione Serramenti PVC e Nuovi Uffici
PVC Windows Division and New Offices





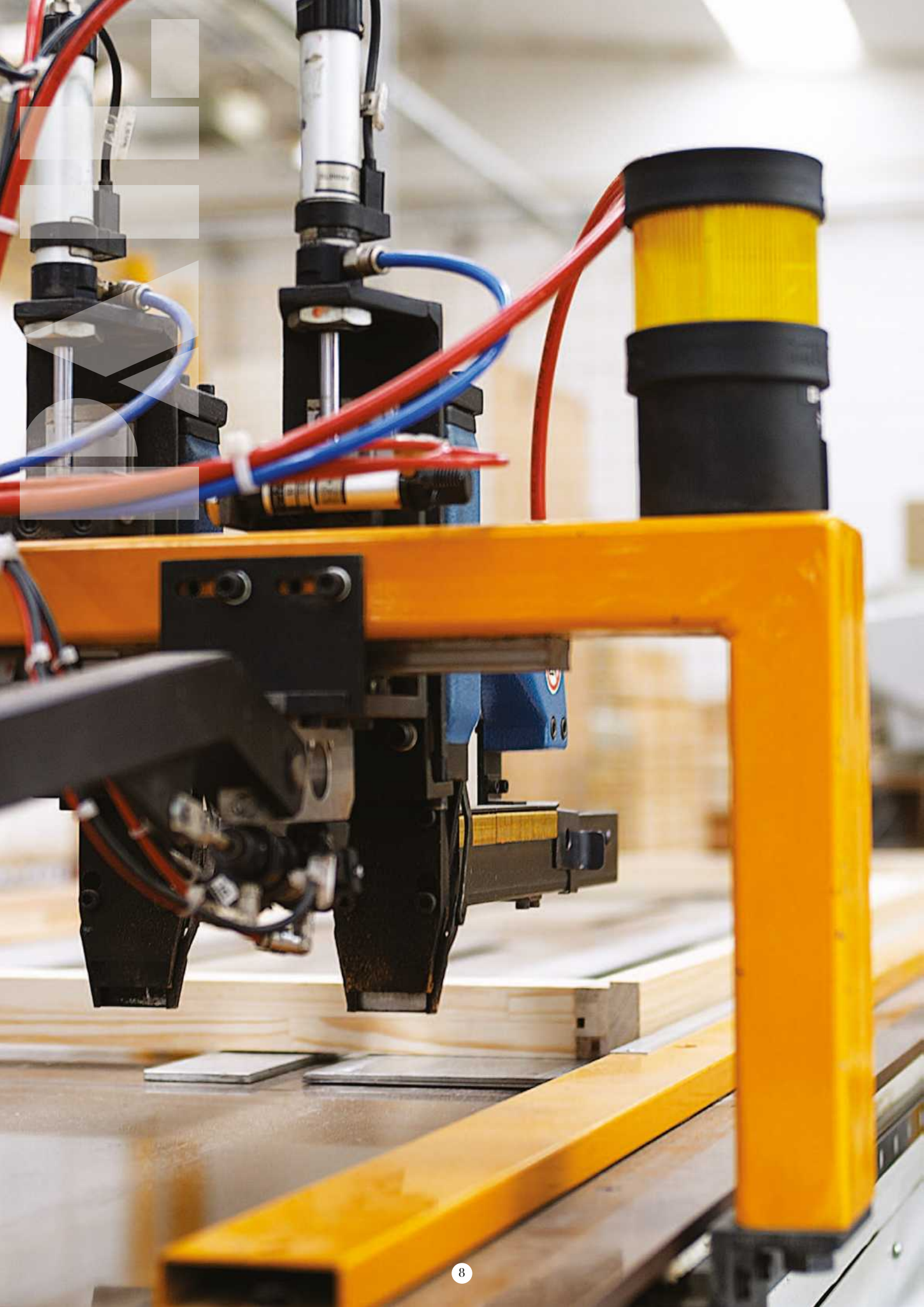



technology

elevata flessibilità produttiva

L'utilizzo di sofisticati impianti computerizzati e macchine a controllo numerico consente agli uomini PAIL di realizzare prodotti personalizzati e su misura, coniugando gli elevati standard qualitativi della produzione industriale con la flessibilità tipicamente artigianale.

high working flexibility

PAIL produces high customized items by advanced technology controlled machines combining the industrial production quality standard with the craftsmanship flexibility.





hand care

sintesi di artigianalità e tecnologia

La Pail è una sintesi di artigianalità e tecnologia, proiettata verso l'innovazione e tesa al rinnovamento continuo. Il nostro lavoro si basa sulla competenza dei nostri uomini, che hanno saputo evolversi nel rispetto della tradizione e della cura di ogni singolo prodotto. Sin dall'origine al semilavorato viene assegnato un codice a barre che ne identifica le caratteristiche tecniche e ne consente il controllo e monitoraggio durante tutta la produzione.

mixes craft and technology

Pail mixes craft and technology, it aims at innovation and steady renewal. Our work starts from our men's skills, that have been able to evolve respecting tradition and care for every single item. Since the request, draw materials are given a bar-code that shows the technical characteristics.





Pail point

le nostre esposizioni

Nei nostri showroom, eleganti e confidenziali, apprezzerete l'ampiezza della gamma di porte e serramenti firmata da PAIL; personale qualificato vi consiglierà nella scelta dei modelli che meglio si adattano alle caratteristiche dei vostri ambienti.

our exhibitions

In our showrooms, elegant and confidential, you can find all the products signed by PAIL; qualified staff give you advices in order to the choose of items for yours interiors.

certificazioni _ certifications





Collezione **CONTEMPORA**

Essenze

*le linee sorprendenti
della contemporaneità*

Marsia





Marsia

Versione: Cieca
Finitura: Spazzolato laccato bianco
Telaio: Design
Maniglia: Senza foro chiave

Version: Shutter door
Finishing: Brushed white lacquered
Frame: Design
Handles: Without key hole



Marsia

Versione: Cieca
Finitura: Spazzolato laccato RAL 3020
Telaio: Design
Maniglia: Senza foro chiave

Version: Shutter door
Finishing: Brushed lacquered RAL 3020
Frame: Design
Handles: Without key hole



Marsia

Versione: Cieca
Finitura: Laccato spazzolato RAL 9001
con inserto centrale
Telaio: Design
Maniglia: Con foro chiave

Version: Shutter door
Finishing: Brushed RAL 9001 lacquered
with central insert
Frame: Design
Handles: With key hole



Marsia

Versione: Cieca
Finitura: Rovere fumè cera
Telaio: Design
Maniglia: Senza foro chiave

Version: Shutter door
Finishing: Cera fumè oak
Frame: Design
Handles: Without key hole



Marsia

Versione: Vetro
Finitura: Rovere
Telaio: Standard
Maniglia: Con foro chiave

Version: Glass
Finishing: Oak
Frame: Standard
Handles: With key hole



Marsia

Versione: Cieca con n°.1 inserto in vetro laccato lucido verticale (a richiesta)

Finitura: Rovere bianco cera

Telaio: Design

Maniglia: Con foro chiave

Version: Shutter door with n°.1 vertical insert with laquered (optional)

Finishing: White tinted oak

Frame: Design

Handles: With key hole



Marsia

Versione: Cieca
Finitura: Multinoce
Telaio: Standard
Maniglia: Con foro chiave

Version: Shutter door
Finishing: Multiwalnut
Frame: Standard
Handles: With key hole



Marsia

Versione: Cieca
Finitura: Multiciliegio
Telaio: Standard
Maniglia: Con foro chiave

Version: Shutter door
Finishing: Multicherry
Frame: Standard
Handles: With key hole



Marsia

Versione: Cieca
Finitura: Multirovere
Telaio: Standard
Maniglia: Con foro chiave

Version: Shutter door
Finishing: Multioak
Frame: Standard
Handles: Without key hole



Marsia

Versione: Cieca
Finitura: Multicanaletto
Telaio: Standard
Maniglia: Con foro chiave

Version: Shutter door
Finishing: Multicanaletto
Frame: Standard
Handles: With key hole



Demetra

Versione: Cieca
Finitura: Rovere fumè cera
Telaio: Design
Maniglia: Senza foro chiave

Version: Shutter door
Finishing: Slate oak wax
Frame: Design
Handles: Without key hole





Demetra

Versione: Cieca
Finitura: Spazzolato RAL 9002
Telaio: Design
Maniglia: Senza foro chiave

Version: Shutter door
Finishing: Brushed RAL 9002
Frame: Design
Handles: Without key hole



Demetra

Versione: Cieca
Finitura: Wengè
Telaio: design
Maniglia: Con foro chiave

Version: Shutter door
Finishing: Wengè
Frame: Design
Handles: With key hole



Infinita

Versione: Cieca

Finitura: Rovere tortora cera
con 2 inserti verticali cromo satinato

Telaio: Design

Maniglia: Con foro chiave

Version: Shutter door

*Finishing: Tortora tinted oak
with 2 satin chrome inserts*

Frame: Design

Handles: With key hole



Infinita

Versione: Cieca
Finitura: Rovere moro cera
Telaio: Design
Maniglia: Senza foro chiave

Version: Shutter door
Finishing: Moro tinted oak
Frame: Design
Handles: Without key hole



Infinita

Versione: Citeca
Finitura: Noce Nazionale
Telaio: Standard
Maniglia: Con foro chiave

Version: Shutter door
Finishing: Italian Walnut
Frame: Standard
Handles: With key hole



Infinita Variant

Versione: Cieca
Finitura: Rovere
Telaio: Telaio e mostre elisse traverso piatto
Maniglia: Con foro chiave

Version: Shutter door
Finishing: Oak
Frame: Frame and exhibitions across flat ellipse
Handles: With key hole



Antea Variant

Versione: Cieca
Finitura: Rovere castagno cera
Telaio: Standard
Maniglia: Con foro chiave

Version: Shutter door
Finishing: Chestnut tinted oak
Frame: Standard
Handles: With key hole

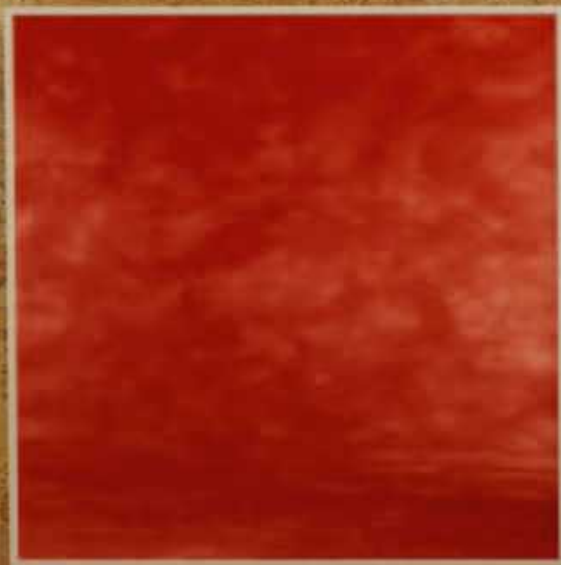



Antea Variant

Versione: Cieca
Finitura: Ciliegio
Telaio: Standard
Maniglia: Con foro chiave

Version: Shutter door
Finishing: Cherry
Frame: Standard
Handles: With key Hole



Antea

Versione: Cieca
Finitura: Rovere
Telaio: Standard
Maniglia: Con foro chiave

Version: Shutter door
Finishing: Oak
Frame: Standard
Handles: With key hole



Dalila

Versione: Cieca
Finitura: Rovere
Telaio: Standard
Maniglia: Con foro chiave

Version: Shutter door
Finishing: Rovere
Frame: Standard
Handles: With key hole



Galaxia 10 Variant

Versione: Cieca
Finitura: Rovere
Telaio: Design
Maniglia: Con foro chiave

Version: Shutter door
Finishing: Oak
Frame: Design
Handles: With key hole



Retrò

Versione: Cieca
Finitura: Rovere tabacco cera
con inserto cromo satinato
Telaio: Design
Maniglia: Con foro chiave

Version: Shutter door
Finishing: Tobacco tinted oak
with satin chrome insert
Frame: Design
Handles: With key hole



Retrò

Versione: Cieca
Finitura: Rovere bianco cera
con inserto cromo satinato
Telaio: Design
Maniglia: Con foro chiave

Version: Shutter door
Finishing: White tinted oak
with satin chrome insert
Frame: Design
Handles: With key hole



Reflex

Versione: Cieca
Finitura: Rovere tortora cera
Telaio: Etere line
Maniglia: Con foro chiave

Version: Shutter door
Finishing: Tortora tinted oak
Frame: Etere line
Handles: With key hole





Replay

Versione: Cieca
Finitura: Wengè
Telaio: Etere line
Maniglia: Con foro chiave

Version: Shutter door
Finishing: Wengè
Frame: Etere line
Handles: With key hole



Replay

Versione: Cieca
Finitura: Rovere
Telaio: Design
Maniglia: Con foro chiave

Version: Shutter door
Finishing: Rovere
Frame: Design
Handles: With key hole



Pegaso 4

Versione: Cieca
Finitura: Laccato bianco
Telaio: Design
Maniglia: Senza foro chiave

Version: Shutter door
Finishing: White lacquered
Frame: Design
Handles: Without key hole

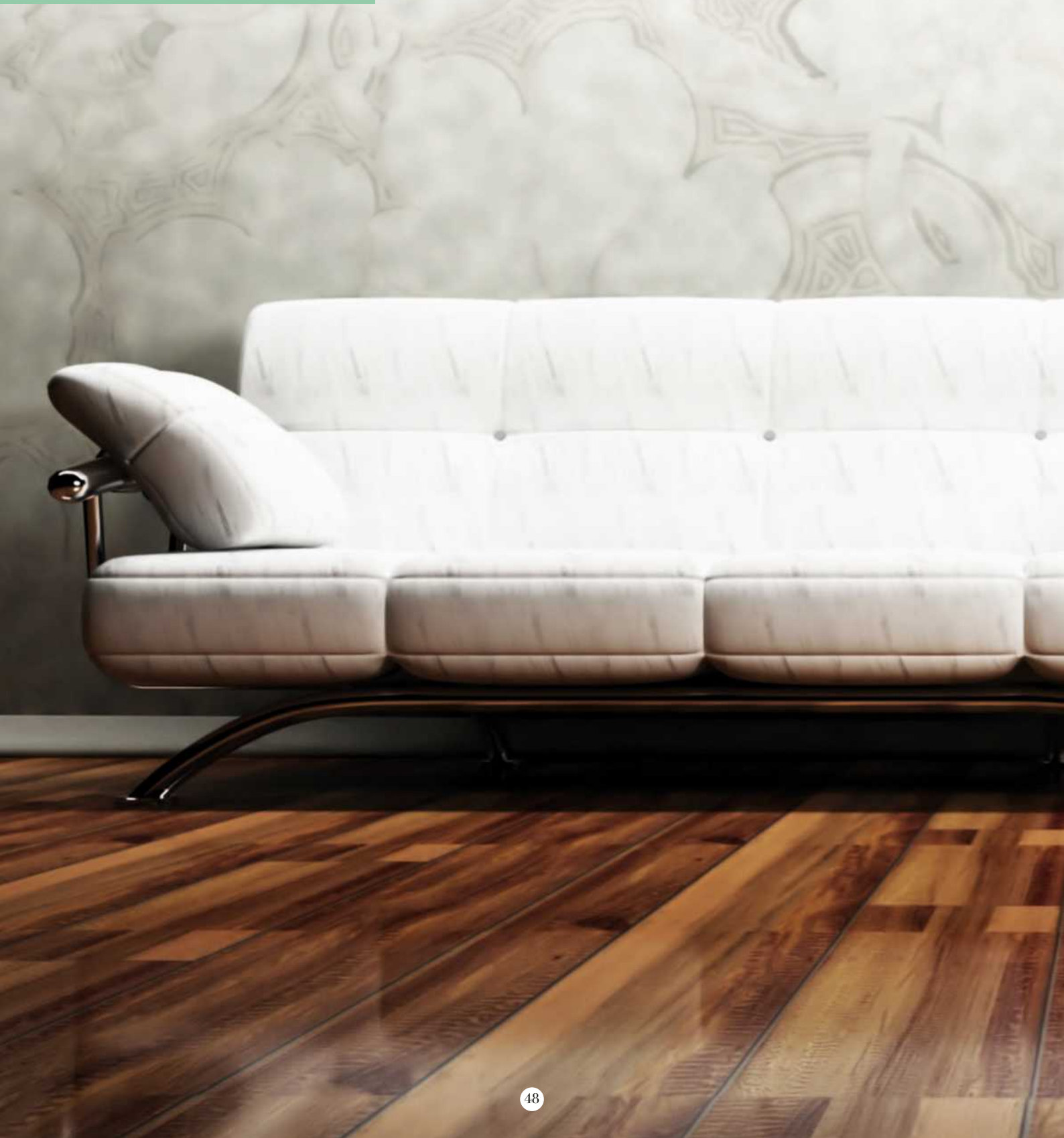



Pegaso 11

Versione: Cieca
Finitura: Rovere
Telaio: Standard
Maniglia: Con foro chiave

Version: Shutter door
Finishing: Oak
Frame: Standard
Handles: With key hole



Pegaso 7

Versione: Cieca
Finitura: Laccato RAL 9002
Telaio: Design
Maniglia: Senza foro chiave

Version: Shutter door
Finishing: Lacquered RAL 9002
Frame: Design
Handles: Without key hole



Pegaso 9

Versione: Cieca
Finitura: Laccato RAL 9001
Telaio: Design
Maniglia: Senza foro chiave

Version: Shutter door
Finishing: Lacquered RAL 9001
Frame: Design
Handles: Without key hole

Pegaso 1

Versione: Cieca
Finitura: Rovere bianco cera
Telaio: Standard
Maniglia: Con foro chiave

Version: Shutter door
Finishing: White tinted oak
Frame: Standard
Handles: With key hole



Pegaso 8

Versione: Cieca
Finitura: Ciliegio
Telaio: Standard
Maniglia: Con foro chiave

Version: Shutter door
Finishing: Cherry
Frame: Standard
Handles: With key hole



Pegaso 9

Versione: Cieca
Finitura: Noce Nazionale
Telaio: Standard
Maniglia: Con foro chiave

Version: Shutter door
Finishing: Italian Walnut
Frame: Standard
Handles: With key hole



Pegaso 6

Versione: Cieca
Finitura: Laccato bianco
Telaio: Design
Maniglia: Senza foro chiave

Version: Shutter door
Finishing: White lacquered
Frame: Design
Handles: Without key hole



Riga



Riga 2020

Versione: Cieca
Finitura: Laccato RAL 1015
Telaio: Design
Maniglia: Senza foro chiave

Version: Shutter door
Finishing: RAL 1015 lacquered
Frame: Design
Handles: Without key hole



Riga 2014

Versione: Cieca
Finitura: Laccato bianco
Telaio: Design
Maniglia: Senza foro chiave

Version: Shutter door
Finishing: White laquered
Frame: Design
Handles: Without key hole



Riga 2018

Versione: Cieca
Finitura: Laccato RAL 1013
Telaio: Design
Maniglia: Senza foro chiave

Version: Shutter door
Finishing: RAL 1013 laquered
Frame: Standard
Handles: Without key hole



Riga 2014

Riga 2019

Versione: Cieca
Finitura: Laccato bianco
Telaio: Design
Maniglia: Senza foro chiave

Version: Shutter door
Finishing: White lacquered
Frame: Design
Handles: Without key hole



Riga 2019



Riga 2015

Versione: Cieca
Finitura: RAL 1013
Telaio: Standard
Maniglia: Con foro chiave

Version: Shutter door
Finishing: RAL 1013
Frame: Standard
Handles: With key hole

Linea

Versione: Cieca
Finitura: Laccato bianco con 4 inserti
orizzontali cromo satinato
Telaio: Standard
Maniglia: Con foro chiave

*Version: Shutter door
Finishing: white lacquered with n.4 horizontal
satin chrome inserts
Frame: Standard
Handles: With key Hole*



Linea

Versione: Cieca
Finitura: Laccato lucido RAL 3020
Telaio: Design
Maniglia: Senza foro chiave

Version: Shutter door
Finishing: High-gloss lacquer RAL 3020
Frame: Design
Handles: Without key hole



Linea

Versione: Cieca
Finitura: Rovere castagno cera
Telaio: Standard
Maniglia: Con foro chiave

Version: Shutter door
Finishing: Chestnut tinted oak
Frame: Standard
Handles: With key Hole



Linea

Versione: Cieca
Finitura: Anta laminato plastico blu
Telaio: Standard tanganica naturale
Maniglia: Con foro chiave

Version: Shutter door
Finishing: Blue plastic rolled door
Frame: Standard natural tanganyika
Handles: With key hole



Mistral Lux

Versione: Vetro
Finitura: Anta alluminio satinato
Telaio: Alluminio satinato
Maniglia: Con foro chiave

Version: Glass
Finishing: Brushed aluminum door
Frame: Brushed aluminum
Handles: With key hole



Mistral

Versione: Cieca

Finitura: Anta laminato plastico bianco

Telaio: Alluminio verniciato bianco

Version: Shutter door

Finishing: White plastic laminated door

Frame: White painted aluminum



Ghibli

Versione: Cieca
Finitura: Marsia wengè con 4 inserti
Telaio: Alluminio satinato
Maniglia: Con foro chiave

Version: Shutter door
Finishing: Marsia wengè with 4 inserts
Frame: Satin aluminum
Handles: With key hole



Mimetica

Versione: Cieca TP o SP
Finitura: Melaminico bianco grezzo da verniciare
Telaio: Alluminio estruso a scomparsa
Maniglia: Senza foro chiave

Version: Shutter door
Finishing: Raw white melamine paper to be painted
Frame: Sliding aluminium
Handles: With out key hole



Finitura: Fumè cera

Finishing: Fumè tinted oak



Collezione **CLASS**

Essenze

*lo stile che segna
il gusto di ogni tempo*

Gaia 11

Versione: Cieca
Finitura: Wengè
Telaio: Standard
Maniglia: Con foro chiave

Version: Shutter door
Finishing: Wengè
Frame: Standard
Handle: With key hole



Gaia 26

Versione: Vetro h mm 2400
Finitura: Rovere Fumè Cera
Telaio: Standard mostre a filo luce
Maniglia: Con foro chiave

Version: Glass
Finishing: Fumè tinted oak
Frame: Standard shows light wire
Handle: With key hole



Gaia 25

Versione: Cieca
Finitura: Wengè
Telaio: Standard
Maniglia: Con foro chiave

Version: Shutter door
Finishing: Wengè
Frame: Standard
Handle: With key hole



Gaia 26

Versione: Cieca Con Insetti Vetro Laccato Lucido
Complanare
Finitura: Laccato Bianco
Telaio: Standard con mostre a filo luce
Maniglia: Con foro chiave

Version: Plain leaf with flush Glossy Lacquered
Glass inserts
Finishing: White Lacquered
Frame: Standard flush architraves
Handle: With key hole

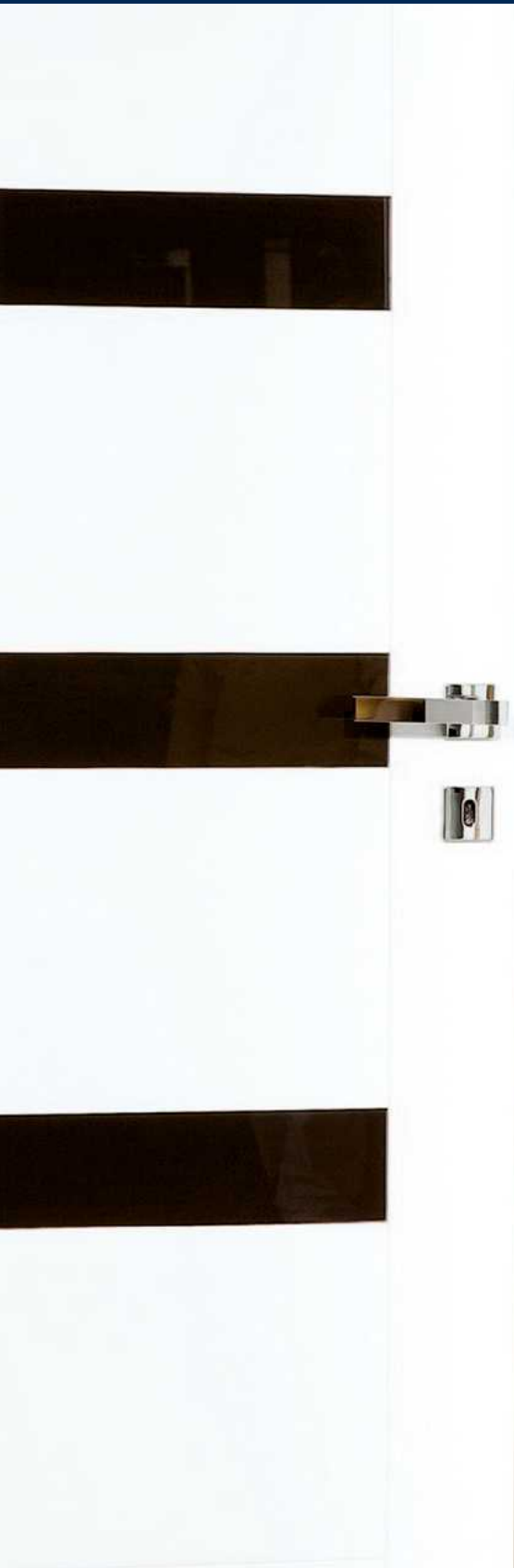

Gaia 1

Versione: Cieca
Finitura: Noce Nazionale
Telaio: Standard, mostre a filo luce
Maniglia: Con foro chiave

Version: Shutter door
Finishing: Italian Walnut
Frame: Standard, flush architraves
Handle: With key hole



Gaia 9

Versione: Cieca
Finitura: Wengè
Telaio: Standard
Maniglia: Con foro chiave

Version: Shutter door
Finishing: Wengè
Frame: Standard
Handle: With key hole



Gaia 9V

Versione: Vetro
Finitura: Laccato Bianco
Telaio: Standard
Maniglia: Con foro chiave

Version: Glass door
Finishing: White Lacquered
Frame: Standard
Handle: With key hole



Gaia 10

Versione: Cieca
Finitura: Noce Nazionale
Telaio: Standard
Maniglia: Con foro chiave

Version: Shutter door
Finishing: Italian Walnut
Frame: Standard
Handle: With key hole



Gaia 10V

Versione: Vetro
Finitura: Rovere bianco cera
Telaio: Standard
Maniglia: Con foro chiave

Version: Glass door
Finishing: White tinted oak
Frame: Standard
Handle: With key hole



Stella 6

Versione: Cieca
Finitura: Laccato RAL 1013
Telaio: Standard
Maniglia: Con foro chiave

Version: Shutter door
Finishing: RAL 1013 Laquere
Frame: Standard
Handle: With key hole





Stella 6

Versione: Duan
Finitura: Laccato RAL 1013
Telaio: Standard
Maniglia: Senza foro chiave

Version: Duan
Finishing: Lacquered RAL 1013
Frame: Standard
Handle: Without key hole



Stella 17

Versione: Cieca
Finitura: Laccato RAL 9002
Telaio: Design
Maniglia: Senza foro chiave

Version: Shutter door
Finishing: Lacquered RAL 9002
Frame: Design
Handle: Without key hole



Stella 2

Versione: Vetro
Finitura: Laccato Bianco
Telaio: Ellisse
Maniglia: Con foro chiave

Version: Glass door
Finishing: White Lacquered
Frame: Ellisse
Handle: With key hole



Novastella 13

Versione: Cieca
Finitura: Laccato Bianco
Telaio: Ellisse
Maniglia: Con foro chiave

Version: Shutter door
Finishing: White Lacquered
Frame: Ellisse
Handle: With key hole



NovaCastello

Versione: Cieca
Finitura: Noce Nazionale
Telaio: Standard
Maniglia: Con foro chiave

Version: Shutter door
Finishing: Italian Walnut
Frame: Standard
Handle: With key hole





Domus

Versione: Vetro
Finitura: Laccato bianco
Telaio: Ellisse
Maniglia: Con foro chiave

Version: Vetro
Finishing: White lacquered
Frame: Ellisse
Handle: With key hole



Domus

Versione: Cieca
Finitura: Noce Nazionale
Telaio: Standard
Maniglia: Con foro chiave

Version: Shutter door
Finishing: Italian Walnut
Frame: Standard
Handle: With key hole



Novatorre

Versione: Cieca
Finitura: Ciliegio
Telaio: Standard
Maniglia: Con foro chiave

Version: Shutter door
Finishing: Cherry
Frame: Standard
Handle: With key hole



Novatorre

Versione: Vetro
Finitura: Rovere
Telaio: Standard
Maniglia: Con foro chiave

Version: Glass door
Finishing: Oak
Frame: Standard
Handle: With key hole



Prestige

Versione: Cieca
Finitura: Ciliegio
Telaio: Standard
Maniglia: Con foro chiave

Version: Shutter door
Finishing: Cherry
Frame: Standard
Handle: With key hole



Prestige

Versione: Cieca
Finitura: Rovere
Telaio: Standard, mostre ellisse, traverso piatto
Maniglia: Con foro chiave

Version: Shutter door
Finishing: Oak
Frame: Standard, architraves ellisse, flat transom
Handle: With key hole



Prestige

Versione: Vetro
Finitura: Noce Nazionale
Telaio: Standard
Maniglia: Con foro chiave

Version: Glass door
Finishing: Italian walnut
Frame: Standard
Handle: With key hole



Prestige

Versione: Cieca
Finitura: Laccato Bianco
Telaio: Standard
Maniglia: Con foro chiave

Version: Shutter door
Finishing: White Lacquered
Frame: Standard
Handle: With key hole



Villa

Versione: Cieca
Finitura: Rovere
Telaio: Standard
Maniglia: Con foro chiave

Version: Shutter door
Finishing: Oak
Frame: Standard
Handle: With key hole



Villa

Versione: Cieca
Finitura: Noce Nazionale
Telaio: Ellisse
Maniglia: Con foro chiave

Version: Shutter door
Finishing: Italian Walnut
Frame: Ellisse
Handle: With key hole



Palatina

Versione: Vetro
Finitura: Laccato Bianco
Telaio: Standard
Maniglia: Con foro chiave

Version: Glass door
Finishing: White Lacquered
Frame: Standard
Handle: With key hole



Palatina

Versione: Cieca
Finitura: Ciliegio
Telaio: Ellisse
Maniglia: Con foro chiave

Version: Shutter door
Finishing: Cherry
Frame: Ellisse
Handle: With key hole



Casale

Versione: Cieca
Finitura: Noce Nazionale
Telaio: Ellisse
Maniglia: Con foro chiave

Version: Shutter door
Finishing: Italian Walnut
Frame: Ellisse
Handle: With key hole



Casale

Versione: Vetro
Finitura: Rovere
Telaio: Standard
Maniglia: Con foro chiave

Version: Glass door
Finishing: Oak
Frame: Standard
Handle: With key hole



finiture, telai e aperture speciali



Sistema Piega

aperture speciali



Sistema Scigno

aperture speciali

Tutte le porte possono essere realizzate con il sistema di apertura speciale SCRIGNO.

Techno Slide

aperture speciali

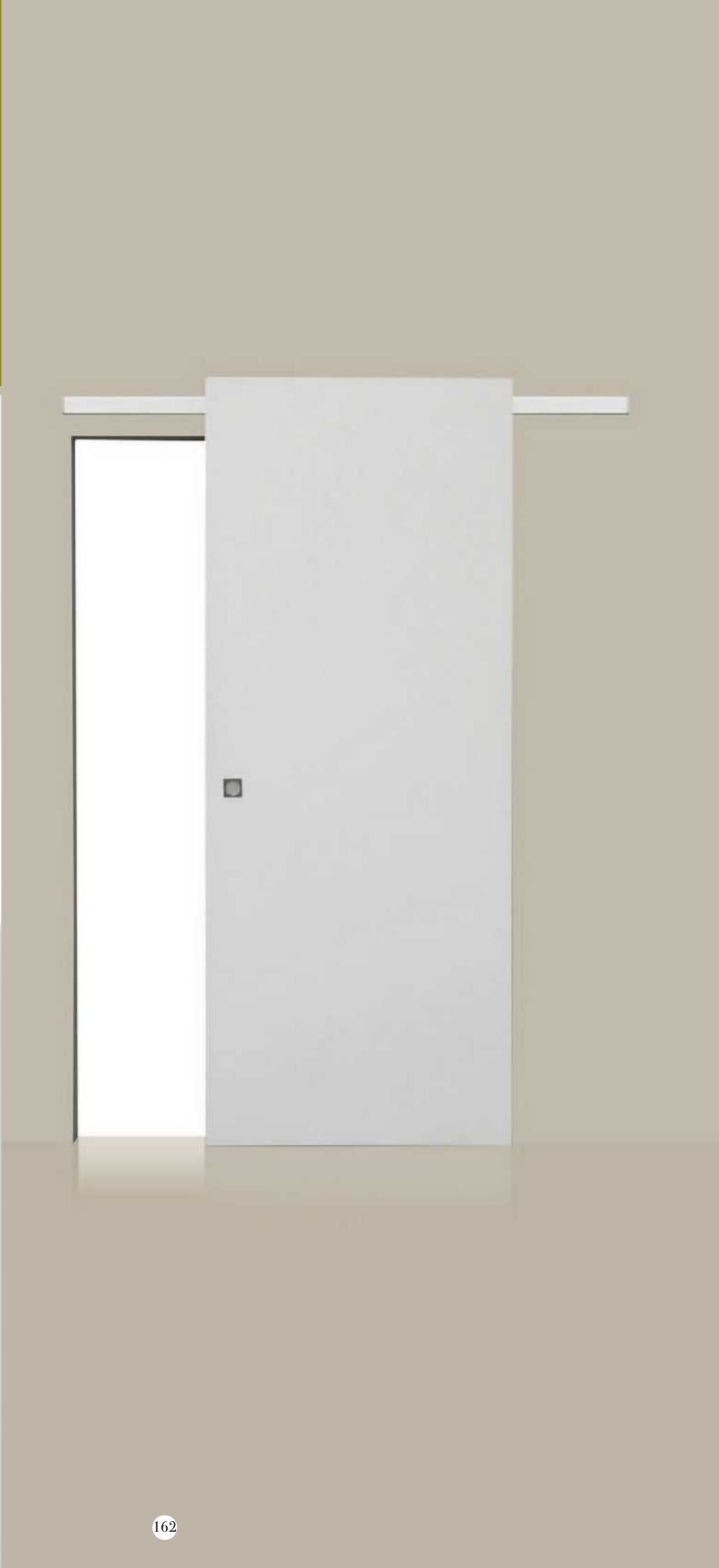

**Scorrevole
esterno
muro**
aperture speciali



**Nova
Libra**
aperture speciali



Sistema Rotea

aperture speciali



*Non disponibile per: mod. GAIA, BELVEDERE, AURORA, ORIZON, STELLA, SIRIO, ORION, VEGA, GHIBLI, RESIDENCE, PRESTIGE, CASTELLO, VILLA, TORRE, CASALE, PALATINA, DOMUS, PORTE CON VETRO.

*Exclusion: mod. GAIA, BELVEDERE, AURORA, ORIZON, STELLA, SIRIO, ORION, VEGA, GHIBLI, RESIDENCE, PRESTIGE, CASTELLO, VILLA, TORRE, CASALE, PALATINA, DOMUS, DOORS WITH GLASS.

Mimetica

aperture speciali



Duan

aperture speciali



Telaio Standard / Frame Standard

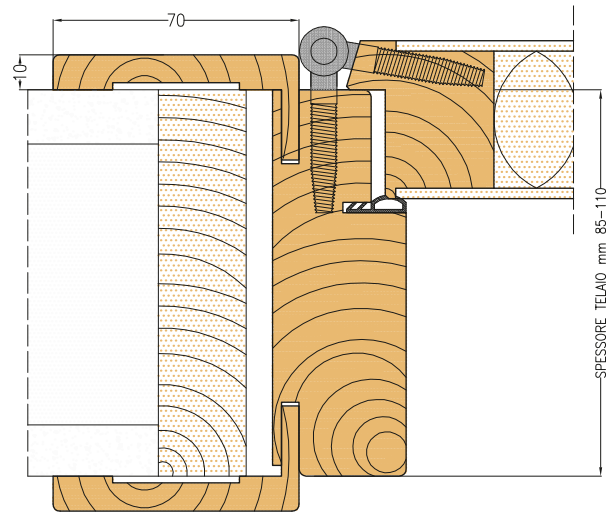

Telaio Design / Frame Design

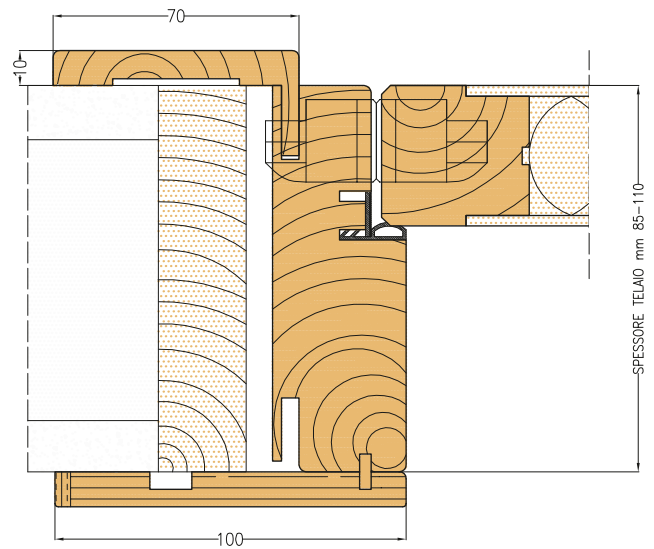

Telaio Ellisse / Frame Ellisse

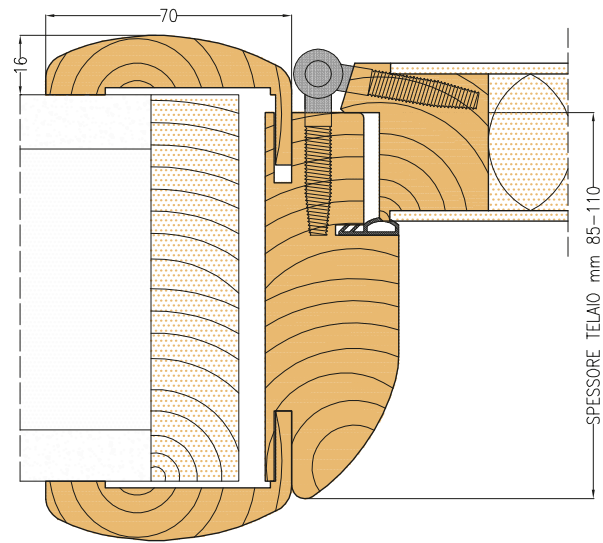

Telaio Eterea Line / Frame Eterea Line

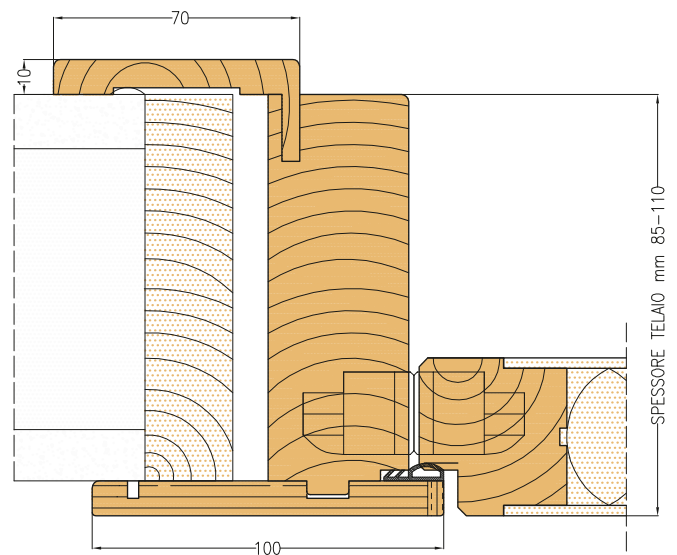

Vetri Satinati Decorati / Decorated Satin Glasses



Mod. MODENA



Mod. PISA



Mod. ROMA



Mod. TORINO



Mod. ANCONA



Mod. PERUGIA



Mod. CHIETI



Mod. PARMA



Mod. MILANO



Mod. PALERMO



Mod. FIRENZE



Mod. NAPOLI



Mod. GENOVA



Mod. PESCARA



Mod. VENEZIA

Nota: I vetri suindicati sono tutti "vetri di sicurezza" (temperati o stratificati). / Note: The glasses indicated are all "safety glasses" (tempered or stratified safety glasses).

Vetri / Glasses

Vetri Satinati Colorati / Colored Satin Glasses



Bianco / White

Blu / Blue

Bronzo / Bronze



Grigio / Gray

Rosa / Pink

Verde / Green

Vetri Laccati Lucidi (2 lati) / Polished Lacquared Glasses (2 faces)

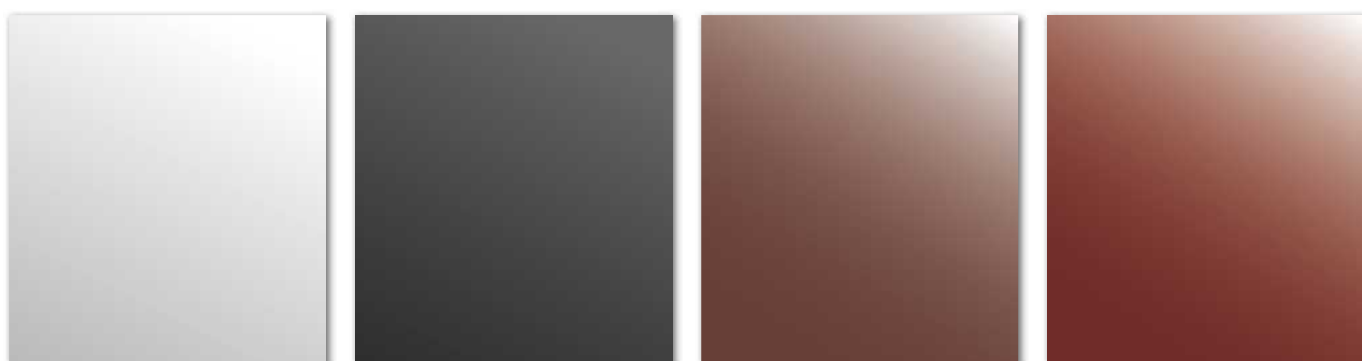

Bianco / White

Nero / Black

Moka / Brown

Bordeaux

L'azienda si riserva il diritto di apportare modifiche e/o integrazioni a prodotti, decorazioni e accessori in qualsiasi momento e senza preavviso.
The Company reserves the right to make changes and/or implementations in products, decorations and accessories at any moment and with no previous notice.
Nota: I vetri suindicati sono tutti "vetri di sicurezza" (temperati o stratificati). / Note: The glasses indicated are all "safety glasses" (tempered or stratified safety glasses).

Decorati

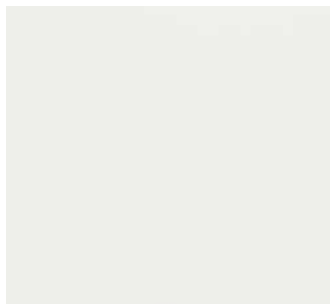

decorato bianco
decorato white



decorato crema
decorato cream



decorato bianco scacchi
decorato white chess



decorato bianco shangai
decorato white shangai



decorato bianco brushed
decorato white brushed



decorato bianco frassino
decorato white ash



decorato rovere provenza
decorato oak provence



decorato lino delavè
decorato Delavè linen



decorato lino kaki
decorato khaki linen



decorato rovere city
decorato oak city



decorato rovere naturale
decorato natural oak



decorato rovere mocaccino
decorato mocaccino



decorato rovere moka
decorato moka oak



decorato rovere sbiancato
decorato white oak



decorato wengé
decorato wengé

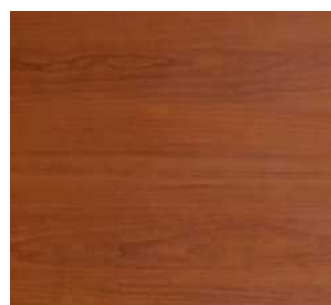

decorato ciliegio
decorato cherry



decorato noce biondo
decorato medium walnut



decorato noce nazionale
decorato italian walnut

Essenze

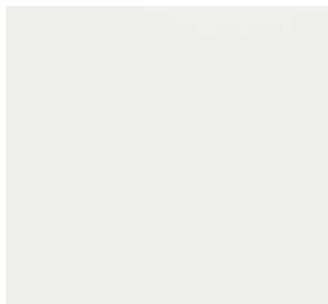

laccato bianco
white lacquered

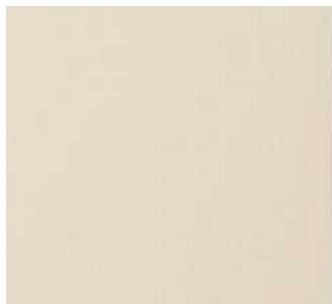

laccato RAL 9001
RAL 9001 lacquered



laccato bianco spazzolato
brushed white lacquered



rovere bianco cera
white tinted oak



rovere tortora cera
tortora tinted oak



rovere castagno cera
chestnut tinted oak



rovere tabacco cera
tobacco tinted oak

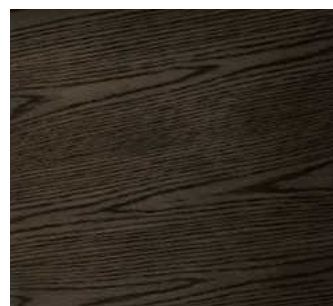

rovere fumé cera
fumè tinted oak



rovere moro cera
moro tinted oak



rovere cacao cera
cacao tinted oak



rovere
oak

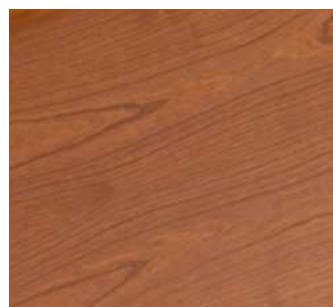

ciliegio
cherry

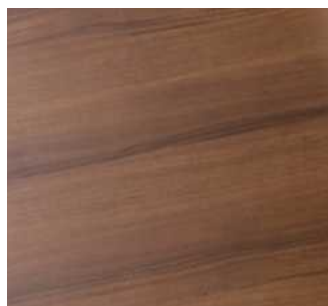

noce nazionale
italian walnut



wengé
wengé



multirovere
multioak



multiciliegio
multicherry

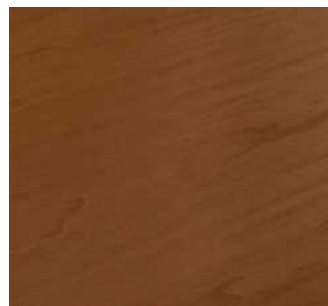

multinoce
multiwalnut

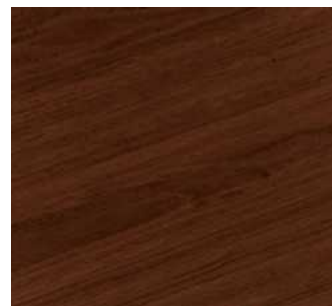

multicanaletto
multicanaletto

Maniglie / Handles



Mod. BASICA
Bronzo / Bronze



Mod. BASICA
Argento / Silver



Mod. SICURA
Resina Nera / Black

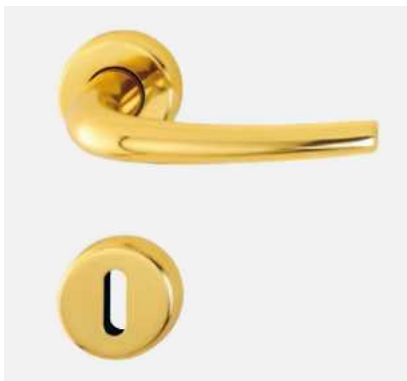

Mod. SINUOSA
Ottone Lucido / Polished Brass



Mod. SINUOSA
Cromo Satinato / Satin Chrome



Mod. SINUOSA
Cromo Lucido / Polished Chrome



Mod. QUADRA
Ottone Lucido / Polished Brass



Mod. QUADRA
Cromo Satinato / Satin Chrome



Mod. QUADRA
Cromo Lucido / Polished Chrome

L'azienda si riserva il diritto di apportare modifiche e/o integrazioni a prodotti, decorazioni e accessori in qualsiasi momento e senza preavviso.
The Company reserves the right to make changes and/or implementations in products, decorations and accessories at any moment and with no previous notice.

l'azienda si riserva il diritto di apportare modifiche e/o integrazioni a prodotti, decorazioni e accessori in qualsiasi momento e senza preavviso.
The Company reserves the right to make changes and/or implementations in products, decorations and accessories at any moment and with no previous notice.

CATALOGO PORTE ESSENZE E DECORATI: seconda edizione
REVISIONE E STAMPA: settembre 2013

Pail Serramenti Srl

Zona Industriale • Via Cagliari 15 - 66041 Atessa (CH) - Italy

Tel. +39 0872 89211

Fax +39 0872 895174

info@pailserramenti.com

www.pailserramenti.com



MADE IN ITALY