



il tuo punto fermo

SECONDA EDIZIONE 2013

ESSENZE E DECORATI



the company

i numeri del nostro successo

La Pail è un'azienda leader nel settore della produzione di porte interne e serramenti in legno, legno-alluminio, alluminio e PVC. Una realtà produttiva che conta oltre 200 dipendenti, suddivisi in quattro stabilimenti che coprono una superficie complessiva di circa 100mila mq (di cui 45mila mq coperti).

Produce annualmente 75mila porte interne, 15mila serramenti esterni, semilavorati e componenti in legno, destinati sia al mercato nazionale che a quello estero.

the numbers of our success

Pail is a leading company in producing internal doors and wooden, wooden-aluminium, aluminium and PVC windows. One productive world that has more than 200 subordinates shared on four factories, on about 100.000 mq surface (45.000 mq covered surface).

Every year Pail makes out 75.000 internal doors, 15.000 external windows, semi-manufactured and wooden components, for home and foreign market.



the family

Amministratore Unico e Legale Rappresentante:
Amerigo Pellegrini

Responsabile Produzione-Acquisti
Sandro Pellegrini

Responsabile Tecnico
Fausto Pellegrini

Responsabile Amministrativo-Finanziario
Paolo Pellegrini

Responsabile Commerciale
Emanuela Pellegrini





50 anni di storia

La nostra storia è quella di una piccola realtà artigianale iniziata 50 anni fa quando Amerigo Pellegrini, giovane falegname, fondò un laboratorio di soli 100 mq per la produzione di porte e finestre in legno. Oggi Amerigo Pellegrini è il presidente della Pail Serramenti, un'azienda che ha saputo evolversi in chiave industriale grazie alla profonda conoscenza del legno, al rispetto di antiche tecniche di lavorazione e alla costante ricerca per l'innovazione tecnologica. Sandro, Fausto, Paolo e Emanuela Pellegrini affiancano oggi il padre nella gestione di questa grande Azienda.

50 years history

This is a story about a small world, that began 50 years ago when Amerigo Pellegrini, young carpenter, started a craftmade lab on just 100 mq, in order to produce wooden doors and windows. Nowadays Amerigo Pellegrini is the President of the Pail Serramenti, a company that has been able to evolve in an industrial way, thanks to a deep knowledge of wood, thanks to respect for old work-techniques and steady research to technological innovation. Sandro, Fausto, Paolo and Emanuela Pellegrini stay by their father, managing this big Company.

1963

Inizio dell'attività di falegnameria
Start of carpentry

1972

Primo stabilimento industriale PAIL 1 (750 mq)
First industrial factory PAIL 1 (750 mq)

1975

Sviluppo mercato interregionale e prime commesse estere
Shop for the interregional market and the first foreign contracts

1985

Ampliamento stabilimento PAIL 1 a 6.000 mq
Factory expansion to PAIL 1 6.000 mq

1994

Apertura stabilimento PAIL 4 (10.000 mq)
Open factory PAIL 4 (10.000 mq)

1998

Apertura stabilimento PAIL 2 (18.000 mq)
Open PAIL 2 factory (18.000 mq)

2003

Apertura stabilimento PAIL 3 (10.000 mq)
Open PAIL 3 factory (10.000 mq)

2009

Avvio Divisione Serramenti PVC e Nuovi Uffici
PVC Windows Division and New Offices





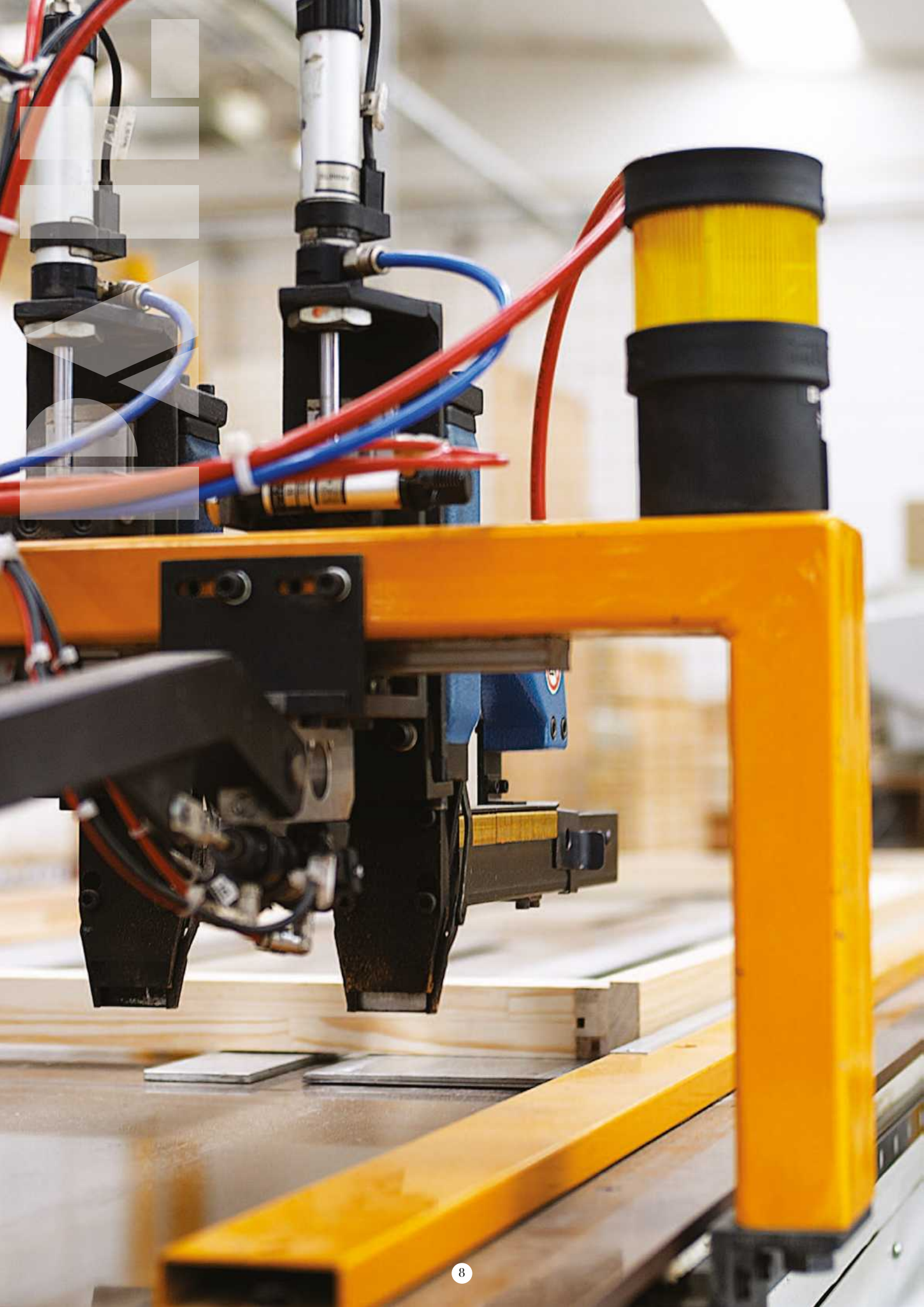



technology

elevata flessibilità produttiva

L'utilizzo di sofisticati impianti computerizzati e macchine a controllo numerico consente agli uomini PAIL di realizzare prodotti personalizzati e su misura, coniugando gli elevati standard qualitativi della produzione industriale con la flessibilità tipicamente artigianale.

high working flexibility

PAIL produces high customized items by advanced technology controlled machines combining the industrial production quality standard with the craftsmanship flexibility.





hand care

sintesi di artigianalità e tecnologia

La Pail è una sintesi di artigianalità e tecnologia, proiettata verso l'innovazione e tesa al rinnovamento continuo. Il nostro lavoro si basa sulla competenza dei nostri uomini, che hanno saputo evolversi nel rispetto della tradizione e della cura di ogni singolo prodotto. Sin dall'origine al semilavorato viene assegnato un codice a barre che ne identifica le caratteristiche tecniche e ne consente il controllo e monitoraggio durante tutta la produzione.

mixes craft and technology

Pail mixes craft and technology, it aims at innovation and steady renewal. Our work starts from our men's skills, that have been able to evolve respecting tradition and care for every single item. Since the request, draw materials are given a bar-code that shows the technical characteristics.





Pail point

le nostre esposizioni

Nei nostri showroom, eleganti e confidenziali, apprezzerete l'ampiezza della gamma di porte e serramenti firmata da PAIL; personale qualificato vi consiglierà nella scelta dei modelli che meglio si adattano alle caratteristiche dei vostri ambienti.

our exhibitions

In our showrooms, elegant and confidential, you can find all the products signed by PAIL; qualified staff give you advices in order to the choose of items for yours interiors.

certificazioni _ *certifications*





Collezione **ALISEA**

Decorati



*tra rigore e originalità
preziose soluzioni innovative*

LN

Versione: Cieca
Finitura: Bianco con 1 inserto centrale
cromo satinato
Telaio: Standard
Maniglia: Con foro chiave

Version: Shutter door
Finishing: White with 1 central
satin chrome insert
Frame: Standard
Handle: With key hole





LN

Versione: Vetro Pescara
Finitura: Wengè
Telaio: Standard
Maniglia: Con foro chiave

Version: Pescara glass door
Finishing: Wengè
Frame: Standard
Handle: With key hole



LN

Versione: Cieca
Finitura: Crema con 1 inserto centrale
cromo satinato
Telaio: Design
Maniglia: Senza foro chiave

Version: Shutter door
Finishing: cream with 1 central
satin chrome insert
Frame: Design
Handle: Without key hole



MS

Versione: Citeca
Finitura: Rovere Provenza
Telaio: Eteera Line
Maniglia: Senza foro chiave

Version: Shutter door
Finishing: Oak Provence
Frame: Eteera Line
Handle: Without key hole





MS

Versione: Citeca
Finitura: Rovere mocaccino
Telaio: Design
Maniglia: Senza foro chiave

Version: Shutter door
Finishing: Mocaccino
Frame: Design
Handle: Without key hole



MS

Versione: Cieca
Finitura: Rovere Moka
Telaio: Design
Maniglia: Senza foro chiave

Version: Shutter door
Finishing: Moka Oak
Frame: Design
Handle: Without key hole



MS

Versione: Cieca
Finitura: Bianco brushed
Telaio: Design
Maniglia: Senza foro chiave

Version: Shutter door
Finishing: White Brushed
Frame: Design
Handle: Without key hole



MS

Versione: Cieca
Finitura: Wengè con 4 inserti orizzontali
cromo satinato
Telaio: Standard
Maniglia: Con foro chiave

Version: Shutter door
Finishing: Wengè with 4 horizontal
satin chrome inserts
Frame: Standard
Handle: With key hole



MS

Versione: Cieca
Finitura: Lino delavè con 1 inserto
centrale cromo satinato
Telaio: Design
Maniglia: Senza foro chiave

Version: Shutter door
Finishing: Delavè linen with 1 central
satin chrome insert
Frame: Design
Handle: Without key hole



MS

Versione: Cieca
Finitura: Rovere Naturale
Telaio: Design
Maniglia: Senza foro chiave

Version: Shutter door
Finishing: Natural Oak
Frame: Design
Handle: Without key hole



MS

Versione: Cieca
Finitura: Lino Kaki
Telaio: Eteera Line
Maniglia: Senza foro chiave

Version: Shutter door
Finishing: Khaki linen
Frame: Eteera Line
Handle: Without key hole



MS

Versione: Cieca
Finitura: Rovere city con 1 inserto
centrale cromo satinato
Telaio: Design
Maniglia: Senza foro chiave

Version: Shutter door
Finishing: Oak city with 1 central
satin chrome insert
Frame: Design
Handle: Without key hole



MS

Versione: Citeca
Finitura: Bianco Shangai
Telaio: Design
Maniglia: Con foro chiave

Version: Shutter door
Finishing: White Shangai
Frame: Design
Handle: With key hole



MS

Versione: Cieca
Finitura: Bianco Scacchi
Telaio: Design
Maniglia: Con foro chiave

Version: Shutter door
Finishing: White Chess
Frame: Design
Handle: With key hole

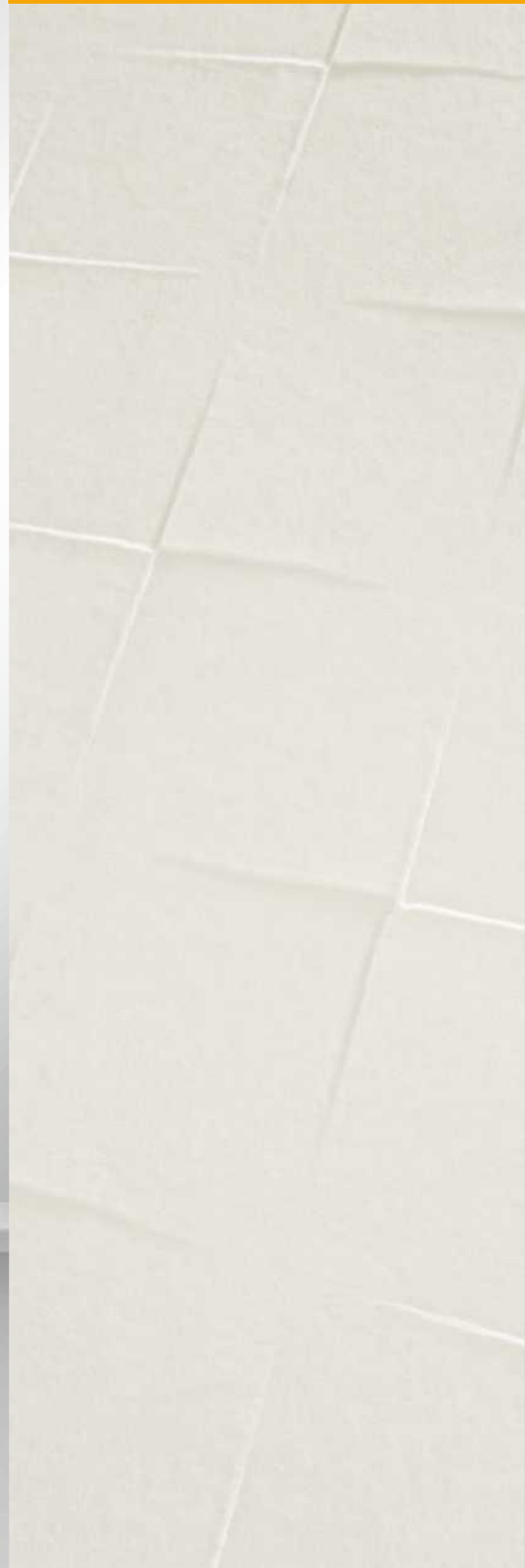

MS

Versione: Citeca
Finitura: Noce Nazionale
Telaio: Standard
Maniglia: Con foro chiave

Version: Shutter door
Finishing: Italian Walnut
Frame: Standard
Handle: With key hole



MS

Versione: Cieca
Finitura: Bianco frassino
Telaio: Design
Maniglia: Senza foro chiave

Version: Shutter door
Finishing: White ash
Frame: Design
Handle: Without key hole



INF

Versione: Cieca
Finitura: Rovere Naturale
Telaio: Design
Maniglia: Senza foro chiave

Version: Shutter door
Finishing: Natural Oak
Frame: Design
Handle: Without key hole





INF

Versione: Cieca
Finitura: Lino Delavè
Telaio: Design
Maniglia: Senza foro chiave

Version: Shutter door
Finishing: Delavè Linen
Frame: Design
Handle: Without key hole



INF

Versione: Cieca
Finitura: Noce Nazionale
Telaio: Standard
Maniglia: Con foro chiave

Version: Shutter door
Finishing: Italian Walnut
Frame: Standard
Handle: With key hole



INF

Versione: Cieca
Finitura: Rovere Provenza
Telaio: Design
Maniglia: Senza foro chiave

Version: Shutter door
Finishing: Oak Provence
Frame: Design
Handle: Without key hole



INF

Versione: Cieca
Finitura: Noce Biondo
Telaio: Standard
Maniglia: Con foro chiave

Version: Shutter door
Finishing: Medium Walnut
Frame: Standard
Handle: With key hole



DMT

Versione: Citeca
Finitura: Rovere Moka
Telaio: Design
Maniglia: Senza foro chiave

Version: Shutter door
Finishing: Moka Oak
Frame: Design
Handle: Without key hole





DMT

Versione: Citeca
Finitura: Ciliegio
Telaio: Ellisse
Maniglia: Con foro chiave

Version: Shutter door
Finishing: Cherry
Frame: Ellisse
Handle: With key hole



DMT

Versione: Cieca
Finitura: Rovere Sbiancato
Telaio: Standard
Maniglia: Con foro chiave

*Version: Shutter door
Finishing: White Oak
Frame: Standard
Handle: With key hole*



DMT

Versione: Citeca
Finitura: Rovere Naturale
Telaio: Design
Maniglia: Senza foro chiave

Version: Shutter door
Finishing: Natural Oak
Frame: Design
Handle: Without key hole



DMT

Versione: Cieca
Finitura: Lino Kaki
Telaio: Design
Maniglia: Senza foro chiave

*Version: Shutter door
Finishing: Khaki linen
Frame: Design
Handle: Without key hole*



DMT

Versione: Cieca
Finitura: Bianco Frassino
Telaio: Design
Maniglia: Senza foro chiave

Version: Shutter door
Finishing: White Ash
Frame: Design
Handle: Without key hole



DMT

Versione: Cieca
Finitura: Rovere moka
Telaio: Design
Maniglia: Senza foro chiave

Version: Shutter door
Finishing: Moka tinted oak
Frame: Design
Handle: Without key hole



RPY

Versione: Citeca
Finitura: Rovere moka
Telaio: Design
Maniglia: Con foro chiave

Version: Shutter door
Finishing: Moka tinted oak
Frame: Design
Handle: With key hole



RTO

Versione: Cieca
Finitura: Rovere mocaccino
Telaio: Design
Maniglia: Con foro chiave

Version: Shutter door
Finishing: Mocaccino tinted oak
Frame: Design
Handle: With key hole



RFX

Versione: Cteca
Finitura: Lino delavè
Telaio: Etereà Line
Maniglia: Con foro chiave

Version: Shutter door
Finishing: Lino delavè
Frame: Etereà Line
Handle: With key hole



LA27V

Versione: Vetro
Finitura: Lino delavè
Telaio: Standard mostre design
Maniglia: Con foro chiave

Version: Shutter door
Finishing: Lino
Frame: Design
Handle: With key hole



LA1V

Versione: Vetro
Finitura: Rovere naturale
Telaio: Standard
Maniglia: Con foro chiave

Version: Glass
Finishing: Rovere naturale
Frame: Standard
Handle: With key hole



LA1C

Versione: Cieca
Finitura: Rovere naturale
Telaio: Standard
Maniglia: Con foro chiave

Version: Shutter door
Finishing: Rovere naturale
Frame: Standard
Handle: With key hole



LA9V

Versione: Vetro
Finitura: Rovere city
Telaio: Standard mostre filo luce
Maniglia: Con foro chiave

Version: Glass
Finishing: Rovere city
Frame: Standard flush architrave
Handle: With key hole



LA9C

Versione: Cieca
Finitura: Wengè
Telaio: Standard mostre filo luce
Maniglia: Con foro chiave

Version: Shutter door
Finishing: Wengè
Frame: Standard flush architrave
Handle: With key hole



LA10C

Versione: Cieca

Finitura: Rovere naturale

Telaio: Standard mostre filo luce

Maniglia: Con foro chiave

Version: Shutter door

Finishing: Rovere naturale

Frame: Standard flush architrave

Handle: With key hole



LA10C

Versione: Cieca
Finitura: Lino caki
Telaio: Standard mostre filo luce
Maniglia: Con foro chiave

Version: Shutter door
Finishing: Lino caki
Frame: Standard flush architrave
Handle: With key hole



LA10V

Versione: Vetro Modena
Finitura: Lino Kaki
Telaio: Standard mostre filo luce
Maniglia: Con foro chiave

Version: Glass Modena
Finishing: Lino Kaki
Frame: Standard flush architraves
Handle: With key hole



LA11C

Versione: Cieca
Finitura: Rovere moka
Telaio: Standard
Maniglia: Con foro chiave

Version: Shutter door
Finishing: Rovere moka
Frame: Standard
Handle: With key hole



LA26C

Versione: Cieca

Finitura: Rovere provenza con inserti
in vetro complanari

Telaio: Standard mostre filo luce

Maniglia: Con foro chiave

Version: Shutter door

Finishing: Rovere provenza with glass inserts

Frame: Standard flush architraves

Handle: With key hole



LA26V

Versione: Vetro
Finitura: Rovere city
Telaio: Standard mostre filo luce
Maniglia: Con foro chiave

Version: Glass
Finishing: Rovere city
Frame: Standard mostre filo luce
Handle: With key hole



finiture, telai e aperture speciali



Sistema Piega

aperture speciali



Sistema Scigno

aperture speciali

Tutte le porte possono essere realizzate con il sistema di apertura speciale SCRIGNO.

Techno Slide

aperture speciali

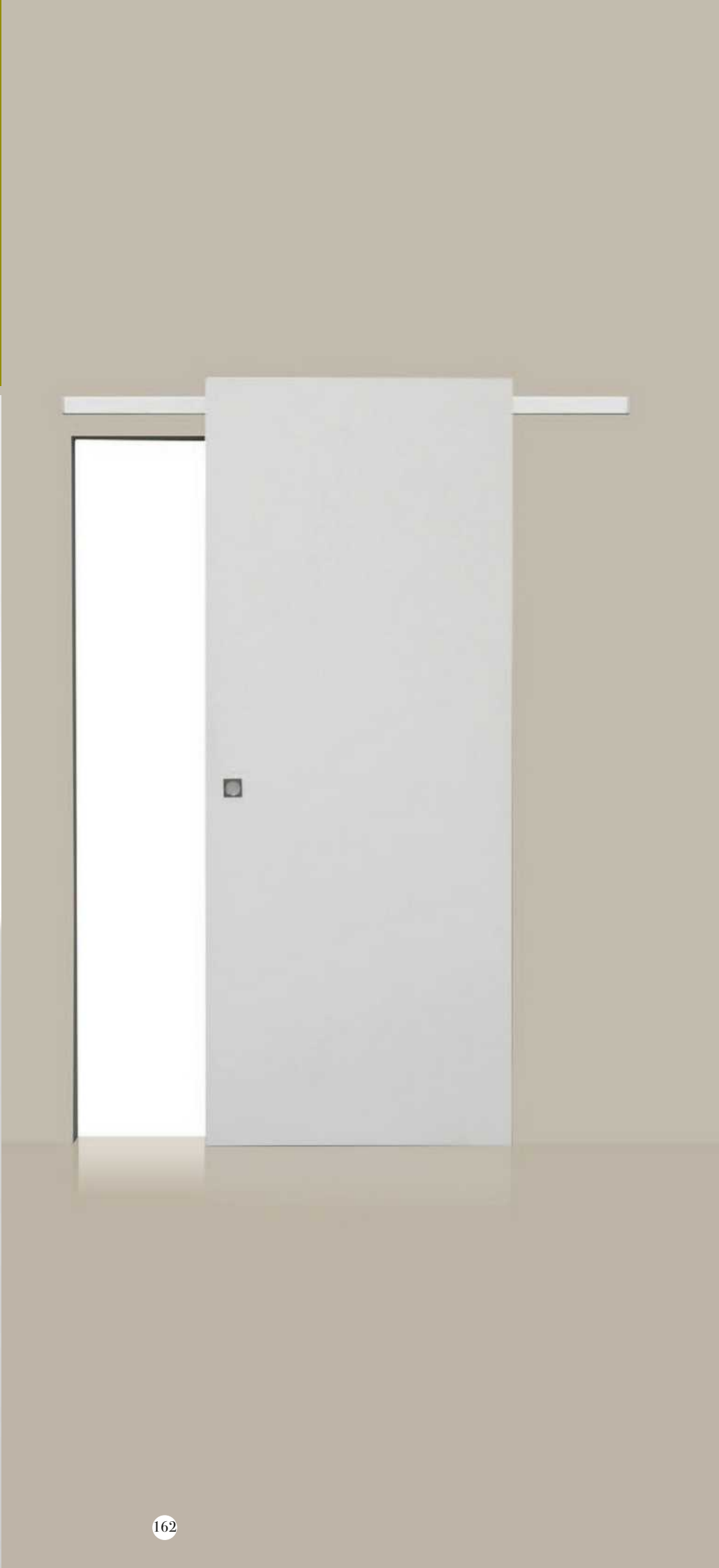

**Scorrevole
esterno
muro**
aperture speciali



**Nova
Libra**
aperture speciali



Sistema Rotea

aperture speciali

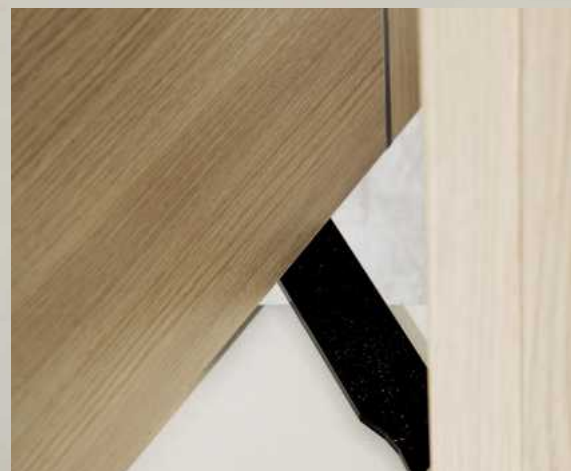

*Non disponibile per: mod. GAIA, BELVEDERE, AURORA, ORIZON, STELLA, SIRIO, ORION, VEGA, GHIBLI, RESIDENCE, PRESTIGE, CASTELLO, VILLA, TORRE, CASALE, PALATINA, DOMUS, PORTE CON VETRO.

*Exclusion: mod. GAIA, BELVEDERE, AURORA, ORIZON, STELLA, SIRIO, ORION, VEGA, GHIBLI, RESIDENCE, PRESTIGE, CASTELLO, VILLA, TORRE, CASALE, PALATINA, DOMUS, DOORS WITH GLASS.

Mimetica

aperture speciali



Duan

aperture speciali



Telaio Standard / Frame Standard

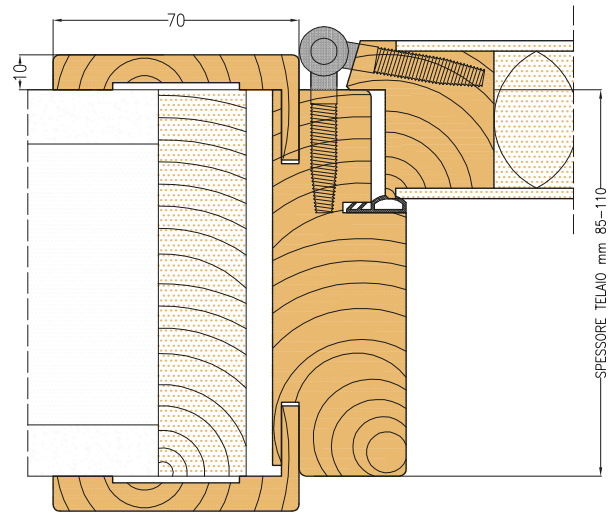

Telaio Design / Frame Design

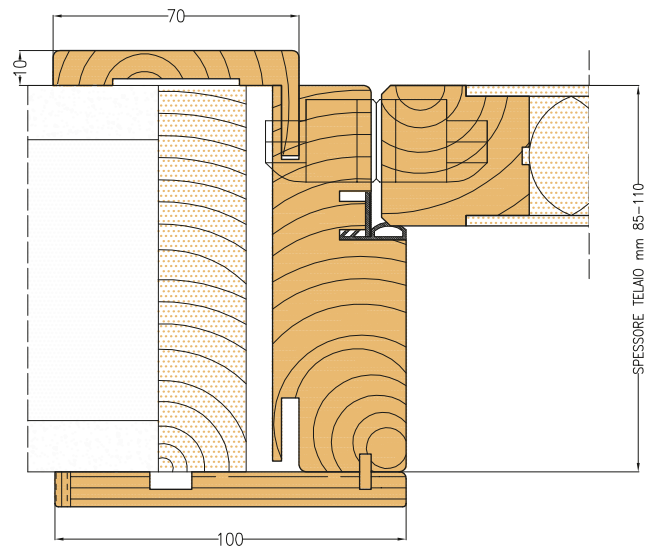

Telaio Ellisse / Frame Ellisse

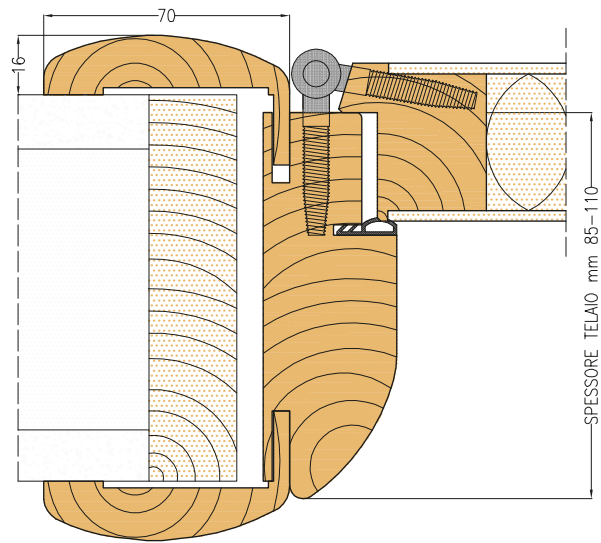

Telaio Eterea Line / Frame Eterea Line

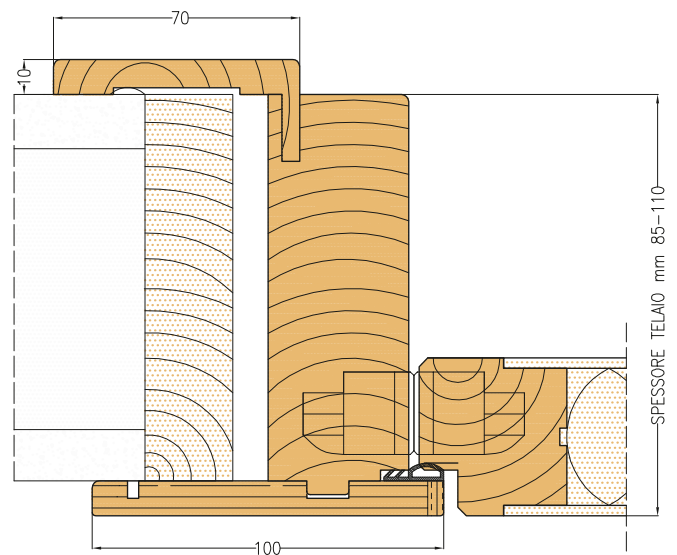

Vetri Satinati Decorati / Decorated Satin Glasses



Mod. MODENA

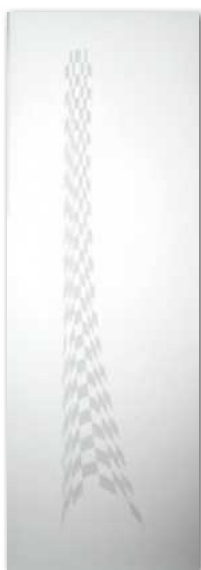

Mod. PISA



Mod. ROMA



Mod. TORINO



Mod. ANCONA



Mod. PERUGIA



Mod. CHIETI



Mod. PARMA



Mod. MILANO



Mod. PALERMO



Mod. FIRENZE



Mod. NAPOLI



Mod. GENOVA



Mod. PESCARA



Mod. VENEZIA

Nota: I vetri suindicati sono tutti "vetri di sicurezza" (temperati o stratificati). / Note: The glasses indicated are all "safety glasses" (tempered or stratified safety glasses).

Vetri / Glasses

Vetri Satinati Colorati / Colored Satin Glasses



Bianco / White

Blu / Blue

Bronzo / Bronze



Grigio / Gray

Rosa / Pink

Verde / Green

Vetri Laccati Lucidi (2 lati) / Polished Lacquered Glasses (2 faces)

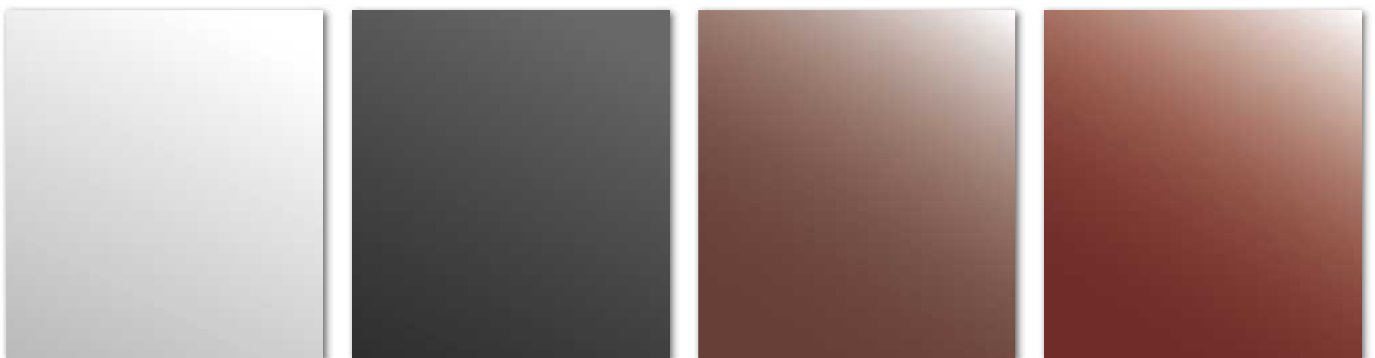

Bianco / White

Nero / Black

Moka / Brown

Bordeaux

L'azienda si riserva il diritto di apportare modifiche e/o integrazioni a prodotti, decorazioni e accessori in qualsiasi momento e senza preavviso.
The Company reserves the right to make changes and/or implementations in products, decorations and accessories at any moment and with no previous notice.
Nota: I vetri suindicati sono tutti "vetri di sicurezza" (temperati o stratificati). / Note: The glasses indicated are all "safety glasses" (tempered or stratified safety glasses).

Decorati

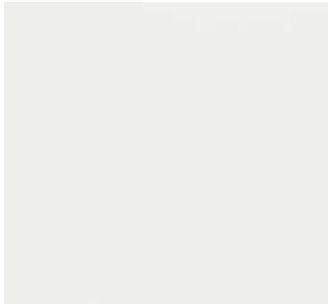

decorato bianco
decorato white



decorato crema
decorato cream



decorato bianco scacchi
decorato white chess



decorato bianco shangai
decorato white shangai



decorato bianco brushed
decorato white brushed



decorato bianco frassino
decorato white ash



decorato rovere provenza
decorato oak provence



decorato lino delavè
decorato Delavè linen



decorato lino kaki
decorato khaki linen



decorato rovere city
decorato oak city



decorato rovere naturale
decorato natural oak



decorato rovere mocaccino
decorato mocaccino

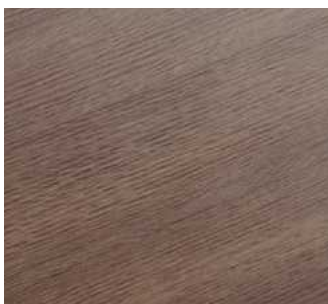

decorato rovere moka
decorato moka oak



decorato rovere sbiancato
decorato white oak



decorato wengé
decorato wengé

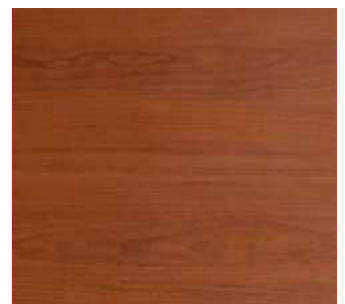

decorato ciliegio
decorato cherry



decorato noce biondo
decorato medium walnut



decorato noce nazionale
decorato italian walnut

Essenze

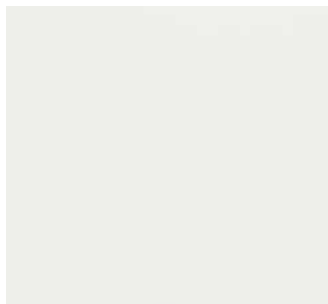

laccato bianco
white lacquered



laccato RAL 9001
RAL 9001 lacquered



laccato bianco spazzolato
brushed white lacquered



rovere bianco cera
white tinted oak



rovere tortora cera
tortora tinted oak



rovere castagno cera
chestnut tinted oak



rovere tabacco cera
tobacco tinted oak



rovere fumé cera
fumè tinted oak



rovere moro cera
moro tinted oak



rovere cacao cera
cacao tinted oak



rovere
oak

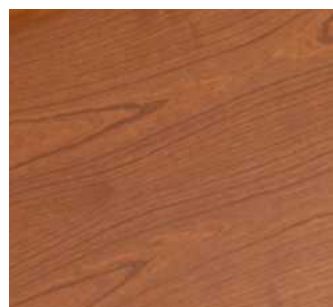

ciliegio
cherry

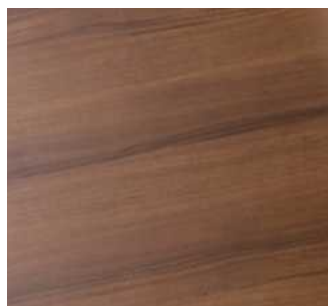

noce nazionale
italian walnut



wengé
wengé



multirovere
multioak



multiciliegio
multicherry

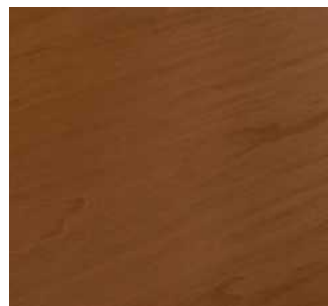

multinoce
multiwalnut

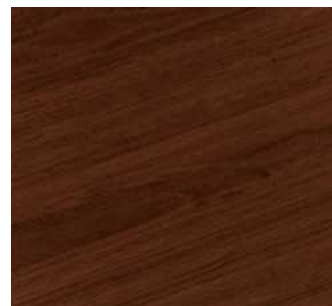

multicanaletto
multicanaletto

Maniglie / Handles



Mod. BASICA
Bronzo / Bronze



Mod. BASICA
Argento / Silver



Mod. SICURA
Resina Nera / Black

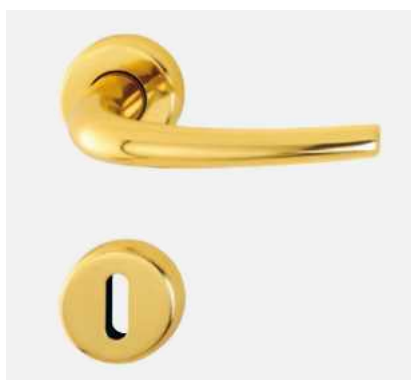

Mod. SINUOSA
Ottone Lucido / Polished Brass

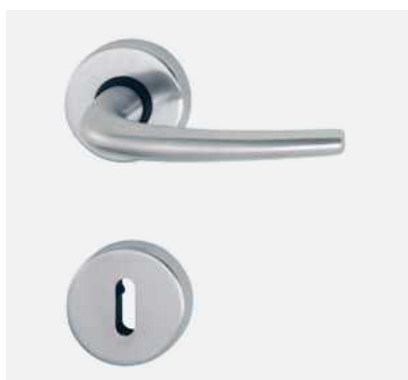

Mod. SINUOSA
Cromo Satinato / Satin Chrome

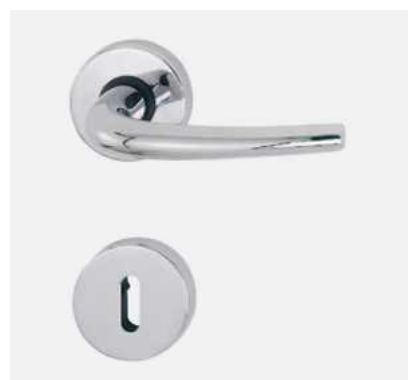

Mod. SINUOSA
Cromo Lucido / Polished Chrome



Mod. QUADRA
Ottone Lucido / Polished Brass



Mod. QUADRA
Cromo Satinato / Satin Chrome



Mod. QUADRA
Cromo Lucido / Polished Chrome

L'azienda si riserva il diritto di apportare modifiche e/o integrazioni a prodotti, decorazioni e accessori in qualsiasi momento e senza preavviso.
The Company reserves the right to make changes and/or implementations in products, decorations and accessories at any moment and with no previous notice.

l'azienda si riserva il diritto di apportare modifiche e/o integrazioni a prodotti, decorazioni e accessori in qualsiasi momento e senza preavviso.
The Company reserves the right to make changes and/or implementations in products, decorations and accessories at any moment and with no previous notice.

CATALOGO PORTE ESSENZE E DECORATI: seconda edizione
REVISIONE E STAMPA: settembre 2013

Pail Serramenti Srl

Zona Industriale • Via Cagliari 15 - 66041 Atessa (CH) - Italy

Tel. +39 0872 89211

Fax +39 0872 895174

info@pailserramenti.com

www.pailserramenti.com



MADE IN ITALY